

## DH-SD6C220I/230I-HC

---

2Mp 20x/30x Full HD HDCVI IR PTZ Dome Camera



### Features

- 20x/30x optical zoom
- Max. 25/30fps@1080P(1920×1080) & 50/60fps@720P resolution
- DWDR, Day/Night(ICR), Ultra DNR, Auto iris, Auto focus
- Control over coaxial cable, long distance real-time transmission
- HD and SD switchable
- Max 240°/s pan speed, 360° endless pan rotation
- Up to 300 presets, 5 auto scan, 8 tour, 5 pattern
- Built-in 2/1 alarm in/out
- Support intelligent 3D positioning with DH-SD protocol
- IR Distance up to 100m
- IP66, OSD

## DH-SD6C220I/230I-HC

### Technical Specifications

| Model                    | DH-SD6C220I-HC   | DH-SD6C230I-HC   |
|--------------------------|--|--|
| <b>Camera</b>            |  |  |
| Image Sensor             | 1/2.8" Exmor CMOS  |  |
| Effective Pixels         | 1920(H) x 1080(V), 2Megapixels   |  |
| Scanning System          | Progressive  |  |
| Electronic Shutter Speed | 1/1 ~ 1/30,000s  |  |
| Min. Illumination        | Color: 0.05Lux@F1.4; B/W:<br>0.005Lux@F1.4; 0Lux (IR on)   | Color: 0.05Lux@F1.6; B/W:<br>0.005Lux@F1.6; 0Lux (IR on) |
| S/N Ratio                | More than 50dB   |  |
| Resolution               | 25/30fps@1080P, 25/30/50/60fps@720P  |  |
| Video Output             | 1-channel BNC HDCVI high definition video output/ CVBS standard definition video output (Can switch) |  |
| <b>Camera Features</b>   |  |  |
| Day/Night                | Auto(ICR) / Color / B/W  |  |
| Backlight Compensation   | BLC / HLC / DWDR (Digital WDR)   |  |
| White Balance            | Auto, ATW, Indoor, Outdoor, Manual   |  |
| Gain Control             | Auto / Manual  |  |
| Noise Reduction          | 2D/3D  |  |
| Privacy Masking          | Up to 24 areas   |  |
| Digital Zoom             | 16x  |  |
| <b>Lens</b>              |  |  |
| Focal Length             | 4.7mm~94mm<br>(20x Optical zoom)   | 4.3mm~129mm<br>(30x Optical zoom)                        |
| Max Aperture             | F1.4 ~ F2.6  | F1.6 ~ F5.0  |
| Focus Control            | Auto / Manual  |  |
| Angle of View            | H: 54.1° ~ 3.2°  | H: 65.1° ~ 2.34°   |
| Close Focus Distance     | 100mm~ 1000mm  |  |
| <b>PTZ</b>               |  |  |
| Pan/Tilt Range           | Pan: 0° ~ 360° endless; Tilt: -15° ~ 90°, auto flip 180°   |  |
| Manual Control Speed     | Pan: 0.1° ~160° /s; Tilt: 0.1° ~120° /s  |  |
| Preset Speed             | Pan: 240° /s; Tilt: 200° /s  |  |
| Preset                   | 300  |  |
| PTZ Mode                 | 5 Pattern, 8 Tour, Auto Pan, Auto Scan   |  |
| Speed Setup              | Human-oriented focal length/ speed adaptation  |  |
| Power up Action          | Auto restore to previous PTZ and lens status after power failure                                     |  |
| Idle Motion              | Activate Preset/ Scan/ Tour/ Pattern if there is no command in the specified period                  |  |
| Protocol                 | DH-SD, Pelco-P/D (Auto recognition)  |  |
| IR Distance              | 100m (2 near IR LED+ 4 far IR LED)   |  |
| <b>Audio</b>             |  |  |

## DH-SD6C220I/230I-HC

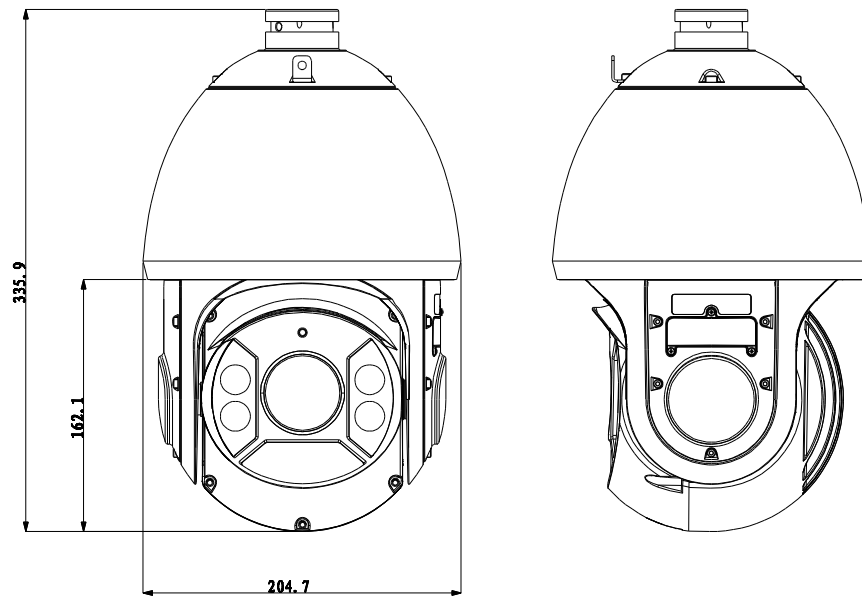

|                            |   |
|----------------------------|---|
| Interface                  | 1 channel In                                    |
| <b>Auxiliary Interface</b> |   |
| RS485                      | 1   |
| Alarm                      | 2/1 channel In/Out                              |
| <b>General</b>             |   |
| Power Supply               | AC 24V/3A ( $\pm 10\%$ )                        |
| Power Consumption          | 10.5W, 26W (IR on, Heater on)                   |
| Working Environment        | -40°C ~ 60°C / Less than 90% RH                 |
| Ingress Protection         | IP66  |
| Vandal Resistance          | N/A   |
| Dimensions                 | $\Phi 204.7(\text{mm}) \times 359.9(\text{mm})$ |
| Weight                     | 7.5kg   |

### Dimensions (mm)









## DH-SD6C220I/230I-HC

### Accessories

|   |   |
|---|---|
|  |  |
| DH-64FB   | Power Supply  |

### Accessories (Optional)

|   |  |   |  |  |  |  |
|---|--|---|--|--|--|--|
|  |  |  |  |  |  |  |
| PFA111  | PFB300C  | PFA112  | PFA113   | PFA120   | PFA150   | PFA151   |

#### **Dahua Technology Co., Ltd.**

1187 BinAn Road, Binjiang District, Hangzhou, China

Tel: +86-571-87688883

Fax: +86-571-87688815

Email: [overseas@dahuatech.com](mailto:overseas@dahuatech.com)

[www.dahuatech.com](http://www.dahuatech.com)

\*Design and specifications are subject to change without notice.

© 2013 Dahua Technology Co., Ltd.